SANIPOTTIE®

PORTABLE / PERMANENT TOILET

OWNER'S MANUAL



Dometic Corporation • Sanitation Systems
13128 State Rt 226, PO Box 38
Big Prairie, OH 44611
SeaLand Product Customer Service: 1-800-321-9886
(8:00 a.m. - 5:00 p.m. ET)

TABLE OF CONTENTS

| | | | |
|--|-------|--|--------|
| Introduction | 2 | Specifications | 8 |
| SaniPottie Operation (multi-lingual) | 3 – 6 | Parts List | 9 – 10 |
| Installing Hold Down Brackets | 7 | Ordering Parts | 10 |
| “MSD” Permanent Installation | 7 | Need Help? | 10 |
| Convenience Products | 8 | Important Information | 11 |
| Maintenance | 8 | Manufacturer’s One-Year Limited Warranty . | 12 |
| Winter Use and Care | 8 | | |

INTRODUCTION

The SaniPottie® portable toilet by SeaLand provides simple operation and convenient disposal of waste. Before using your SaniPottie® portable toilet, we recommend that you read this manual completely. It contains information for Marine models 964/964MSD, 965/965MSD, and RV and camping models 962 and 966. Marine models are provided with hold-down brackets as standard equipment, but are an option for the RV and camping models. Become familiar with the SaniPottie® portable toilet and its components parts. As with any quality product, proper use and operation eliminates unnecessary maintenance.

SANIPOTTIE OPERATION

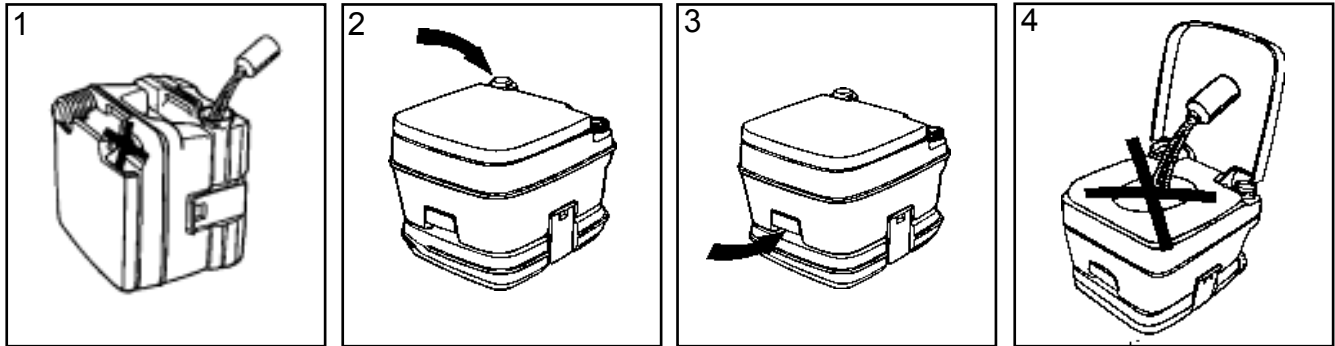

English

1. Set portable toilet on its front side so cap on holding tank is in vertical position. Remove cap and add SeaLand® brand holding tank deodorant following instructions on deodorant container. Replace cap firmly.
2. **BEFORE USING:** Set portable toilet in upright position and remove cap located right, rear side of freshwater tank. Fill with fresh water just below the neck of the freshwater inlet. Depress bellows pump to add water to bowl.
3. **AFTER USING:** To flush, open slide valve by pulling out handle and press bellows pump one or more times. After flushing, close slide valve by pushing handle all the way in.
4. **CAUTION: Never** add holding tank deodorant to the waste holding tank by pouring directly into the toilet bowl.

TO EMPTY HOLDING TANK: (1) Make sure slide valve handle is all the way in. (2) Unlatch upper unit by disengaging side latches and lift from holding tank. (3) Carry holding tank to permanent toilet facility. (4) Remove cap. (5) Empty contents into permanent toilet. (6) Rinse tank thoroughly. (7) Replace cap. (8) Reassemble unit and prepare for use.

CAUTION: Deodorants may be harmful or fatal if swallowed. Avoid breathing of vapor for prolonged or repeated periods. Contact with skin, eyes and mucous membranes should be avoided. Allergic irritation may result from prolonged or repeated contact with skin. **FIRST AID:** If product contacts eyes or skin, flush area immediately with clean water for at least 15 minutes. Get prompt medical attention for eyes. If ingested, give one or two glasses of water or milk. Induce vomiting and contact physician or Poison Control Center immediately.

Français

1. Poser la toilette portable sur le côté avant afin que le bouchon du réservoir d'eau usée soit en position verticale. Retirer le bouchon et ajouter le désodorisant de chasse d'eau SeaLand® en suivant les consignes de l'emballage du désodorisant. Remettre le bouchon en place en vous assurant qu'il est bien fermé.
2. **AVANT L'UTILISATION:** Placer la toilette en position verticale et retirer le bouchon situé à la droite du côté arrière de la cuve d'eau fraîche. Remplir d'eau fraîche juste au dessous du col de l'ouverture pour eau fraîche. Appuyer sur la pompe à soufflets pour ajouter de l'eau à la cuvette.
3. **APRES L'UTILISATION:** Pour évacuer, ouvrir le robinet-vanne en tirant la poignée vers vous et en appuyant sur la pompe à soufflets une ou plusieurs fois. Après l'évacuation, refermer le robinet-vanne en poussant la poignée complètement.
4. **ATTENTION:** Ne jamais ajouter de désodorisant de chasse d'eau au réservoir d'eau usée en versant directement dans la cuvette des toilettes.

POUR VIDER LA CHASSE D'EAU: (1) S'assurer que la poignée du robinet-vanne est complètement poussée. (2) Déverrouiller l'unité supérieure en désenclenchant les loquets latéraux et en les soulevant du réservoir d'eau usée. (3) Transporter le réservoir d'eau usée jusqu'à des toilettes installées de manière permanente. (4) Retirer le bouchon. (5) Vider le contenu dans les toilettes permanentes. (6) Rincer le réservoir soigneusement. (7) Replacer le bouchon. (8) Remonter l'unité et préparer à l'utilisation.

ATTENTION: Les désodorisants peuvent être dangereux ou mortels s'ils sont avalés. Eviter de respirer des vapeurs pendant des périodes répétées ou prolongées. Eviter le contact avec la peau, les yeux et les muqueuses. Un contact répété ou prolongé avec la peau peut provoquer des irritations ou des allergies. **PREMIERS SOINS:** Si le produit entre en contact avec les yeux ou la peau, passer immédiatement sous l'eau pendant au moins 15 minutes, et contacter rapidement un médecin. En cas d'ingestion, donner un verre ou deux de lait ou d'eau. Faire vomir et contacter un médecin ou le Centre de Contrôle des Poisons immédiatement.

SANIPOTTIE OPERATION (cont'd)

Deutsch

1. Die transportable Toilette so auf die Vorderseite stellen, daß die Kappe des Abwassertanks senkrecht nach oben zeigt. Die Kappe abschrauben und das Sanitärzusatzmittel gemäß den Herstellerangaben in den Fäkalientank einfüllen. Kappe wieder fest aufschrauben.
2. **VOR DER BENUTZUNG:** Die transportable Toilette wieder aufrecht hinstellen und die rechts an der Rückseite befindliche Kappe des Frischwassertanks abschrauben. Den Frischwassertank mit Wasser so weit auffüllen, daß der Wasserspiegel gerade an den Hals des Frischwassereinlasses reicht. Pumpe mehrmals niederdrücken, um Wasser in das Becken einzufüllen.
3. **NACH DER BENUTZUNG:** Nach Benutzung den Schieber durch herausziehen am Griff öffnen und durch betätigen der Pumpe das Becken spülen. Nach dem Spülvorgang den Schieber wieder schließen.
4. **VORSICHT:** Niemals Sanitärzusätze direkt über die Schüssel einfüllen.

ENTLEEREN DES ABWSSERTANKS: (1) Sicherstellen, daß der Schieber ganz geschlossen ist. (2) Den Frischwassertank durch Lösen der Halteklammern entriegeln und vom Abwassertank abnehmen. (3) Den Abwassertank zu einer geeigneten Entsorgungsstelle tragen. (4) Die Kappe abschrauben. (5) Den Inhalt ausgießen. (6) Den Abwassertank durch mehrfaches Spülen gründlich reinigen. (7) Kappe wieder aufschrauben. (8) Die Toilette wieder zusammenbauen und für die nächste Benutzung vorbereiten.

VORSICHT: Sanitärzusatzmittel können beim Verschlucken gesundheitsschädlich sein. Evtl. aufsteigende Dämpfe nicht einatmen. Berührungen mit Augen, Haut und Schleimhäuten vermeiden. Bei längeren und wiederholten Hautkontakten kann es zu allergischen Hautreaktionen kommen. Warn- und Sicherheitshinweise auf der Verpackung beachten. **ERSTE HILFE:** Bei Augen- und Hautkontakt sofort mit viel Wasser spülen. Verschmutzte Kleidung entfernen. Bei Augenkontakt sofort einen Augenarzt aufsuchen. Bei Verschlucken sofort viel Wasser verabreichen und Arzt oder Giftzentrale aufsuchen. Verpackung zur Stoffidentifizierung mitnehmen.

Italiano

1. Collocare la toilette portatile con il lato anteriore davanti in modo che il tappo sul serbatoio di contenimento sia in posizione verticale. Togliere il tappo ed aggiungere deodorante SeaLand® per serbatoio di contenimento seguendo le istruzioni sulla confezione. Riposizionare saldamente il tappo.
2. **PRIMA DELL'USO:** Collocare la toilette in posizione diritta e togliere il tappo situato sul lato posteriore destro del serbatoio acqua pulita. Riempire con acqua pulita al disotto del collo apertura di immissione acqua pulita. Premere la pompa a soffiato per aggiungere acqua nella tazza.
3. **DOPO L'USO:** Per scaricare, aprire la valvola a saracinesca tirando la maniglia verso l'esterno e spingere la pompa a soffiato una o più volte. Dopo aver scaricato, chiudere la valvola a saracinesca premendo la maniglia completamente verso l'interno.
4. **ATTENZIONE:** Non aggiungere mai deodorante per serbatoio di contenimento nel serbatoio di scarico versando direttamente il liquido nella tazza.

SVUOTAMENTO SERBATOIO DI CONTENIMENTO: (1) Assicurarsi che la maniglia della valvola a saracinesca sia completamente inserita. (2) Sganciare il gruppo superiore aprendo i dispositivi di fermo laterali e sollevare dal serbatoio di contenimento. (3) Portare il serbatoio di contenimento in una toilette fissa. (4) Togliere il tappo. (5) Versare il contenuto nella toilette fissa. (6) Sciacquare bene il serbatoio. (7) Riposizionare il tappo. (8) Rimontare il gruppo e predisporre per l'utilizzo.

ATTENZIONE: I deodoranti possono rivelarsi nocivi o mortali se inghiottiti. Evitare di respirare le esalazioni per periodi prolungati o ripetuti. Si dovrebbe evitare il contatto con pelle, occhi e membrane mucose. Un contatto prolungato o ripetuto con la pelle potrebbe dare origine ad irritazione allergica. **PRONTO SOCCORSO:** Se il prodotto viene a contatto con occhi o pelle, risciacquare immediatamente a fondo la zona interessata con acqua pulita per almeno 15 minuti. Per gli occhi consultare subito un medico. Se ingerito, bere uno o due bicchieri di acqua o latte. Provocare il vomito e contattare immediatamente un medico o un Centro Controllo Veleni.

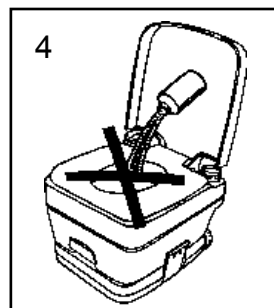
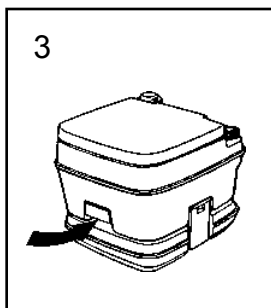
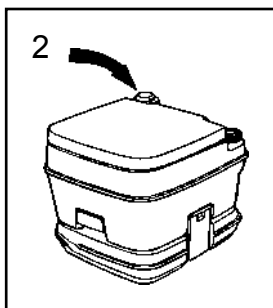
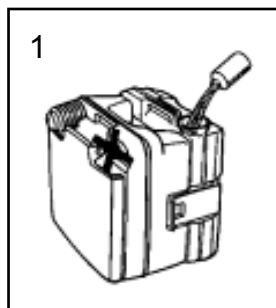

SANIPOTTIE OPERATION (cont'd)

Hollands

1. Plaats het verplaatsbare toilet op zijn voorkant, zodat de opvangtank in verticale stand staat. Verwijder de dop van de opvangtank en voeg de deodorant van het merk SeaLand® volgens de gebruiksaanwijzing toe. Draai de dop weer op de tank.
2. **VOOR GEBRUIK:** Zet het verplaatsbare toilet rechtop en verwijder de dop rechts aan de achterkant van de watertank. Vul de watertank met schoon water tot net onder de hals van de watertoevoer. Druk de balgpomp omlaag om water aan het toilet toe te voegen.
3. **NA GEBRUIK:** Om te spoelen dient u de schuifklep te openen door de hendel uit te trekken en de balgpomp één of meerdere keren in te drukken. Sluit de schuifklep na het spoelen door de handel helemaal in te drukken.
4. **ATTENTIE:** Voeg nooit deodorant, via de toiletspot, toe aan de opvangtank.

HET LEGEN VAN DE OPVANGTANK: (1) Zorg ervoor dat de hendel van de schuifklep helemaal ingedrukt is. (2) Ontgrendel het bovengedeelte door de sluitingen los te maken en deze van de opvangtank te tillen. (3) Draag de opvangtank naar een hiervoor ingerichte stortplaats of vast toilet (aangesloten op het riool). (4) Schroef de dop los. (5) Ledig de inhoud in de stortplaats of vast toilet. (6) Spoel de tank goed schoon. (7) Schroef de dop er weer op. (8) Zet het bovengedeelte met de sluitingen weer vast op de opvangtank en maak hem gereed voor gebruik.

ATTENTIE: Deodorants kunnen gevaarlijk of zelfs dodelijk zijn als ze ingeslikt worden. Vermijd herhaaldelijk of langdurig inademen van de damp. Langdurige of herhaaldelijke aanraking met de huid kan een allergische reactie veroorzaken. **EERSTE HULP:** Als het produkt in aanraking komt met ogen of huid, dient u dit onmiddellijk te spoelen met schoon water minimaal 15 minuten. Als het produkt in de ogen terecht komt dient u zo spoedig mogelijk medische hulp te zoeken. Als het ingeslikt wordt, drink dan één of twee glazen water of melk om braken op te wekken en raadpleeg onmiddellijk een arts.

Español

1. Coloque el inodoro portátil en su lado frontal para que la tapa del tanque de retención quede en posición vertical. Quite la tapa y agregue el desodorante para tanque de retención de la marca SeaLand® siguiendo las instrucciones en el envase del desodorante. Vuelva a colocar la tapa firmemente.
2. **ANTES DE USAR:** Coloque el inodoro portátil en posición vertical y quite la tapa ubicada a la derecha en el lado posterior del tanque de agua limpia. Llénelo con agua limpia justo por debajo del cuello de la entrada de agua limpia. Presione la bomba de fuelle para agregar agua a la taza.
3. **DESPUÉS DE USAR:** Para evacuar los contenidos, abra la válvula deslizante tirando la maneta hacia fuera y presionando la bomba de fuelle una o más veces. Después de eliminar con agua, cierre la válvula deslizante empujando la maneta hacia dentro totalmente.
4. **PRECAUCIÓN:** Nunca agregue desodorante para tanque de retención al tanque de retención de residuos vertiendo directamente dentro de la taza del inodoro.

PARA VACIAR EL TANQUE DE RETENCIÓN: (1) Asegúrese de que la válvula deslizante se encuentra hacia dentro totalmente. (2) Destabe la unidad superior abriendo las clavijas laterales y levantándola del tanque de retención. (3) Lleve el tanque de retención a una instalación de inodoro fijo. (4) Quite la tapa. (5) Vacíe el contenido en un inodoro fijo. (6) Enjuague el tanque concienzudamente. (7) Vuelva a colocar la tapa. (8) Vuelva a armar la unidad y prepárela para su uso.

PRECAUCIÓN: Los desodorantes pueden ser perjudiciales o fatales si se tragan. Evite respirar los vapores durante períodos prolongados o reiterados. El contacto con la piel, los ojos y las membranas mucosas debe ser evitado. Puede resultar una irritación alérgica como causa de contactos prolongados o reiterados con la piel. **PRIMEROS AUXILIOS:** Si el producto entra en contacto con los ojos o la piel, enjuague el área inmediatamente con agua limpia durante al menos 15 minutos. Obtenga atención médica inmediata para los ojos. Si se ingiere proporcione uno o dos vasos de agua o leche. Provoque el vómito y póngase en contacto inmediatamente con un médico o un Centro de intoxicación.

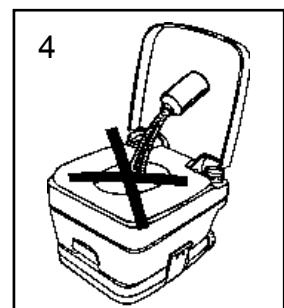
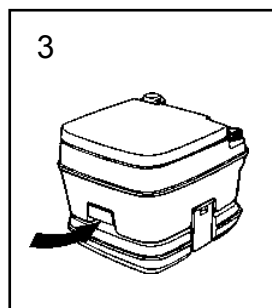
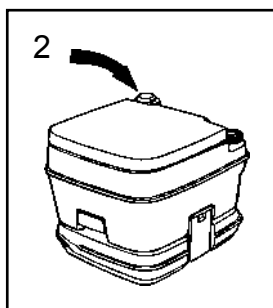
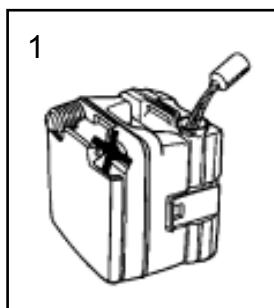

SANIPOTTIE OPERATION (cont'd)

Svensk

1. Vänd den bärbara toalettens framdel nedåt så att uppsamlingstankens lock hamnar i vertikalläge. Avlägsna locket och tillsätt deodorant för uppsamlingstank av märket SeaLand® enligt anvisningarna på deodorantbehållaren. Sätt tillbaka locket ordentligt.
2. **FÖRE ANVÄNDNING:** Ställ den bärbara toaletten upprätt och avlägsna locket till höger baktill på färskvattentanken. Fyll på med färskvatten precis nedanför färskvattensinloppets hals. Tryck på bälgpumpen för att släppa på vatten i toalettskålen.
3. **EFTER ANVÄNDNING:** Spola genom att öppna skjutventilen (dra ut handtaget) och trycka på bälgpumpen minst en gång. Efter spolning skall skjutventilen stängas genom att handtaget trycks in helt.
4. **FÖRSIKTIGHET:** Tillsätt aldrig deodorant för uppsamlingstank i avfallstanken genom att hålla den direkt i toalettskålen.

TÖMNING AV UPPSAMLINGSTANK: (1) Se till att skjutventilens handtag tryckts in helt. (2) Frigör övre enheten genom att lossa sidospärrarna och lyft av enheten från uppsamlingstanken. (3) Transportera uppsamlingstanken till fast toalettanläggning. (4) Avlägsna locket. (5) Töm innehållet i fast toalett. (6) Skölj tanken noggrant. (7) Sätt tillbaka locket. (8) Montera ihop enheten igen och utför förberedelser inför användning.

FÖRSIKTIGHET: Deodoranter kan orsaka personskada eller dödsfall om de sväljs. Undvik att andas in ångorna under lång tid eller vid upprepade tillfällen. Undvik kontakt med huden, ögonen och slemhinnorna. Allergiska reaktioner kan uppstå vid långvarig och upprepade kontakt med huden. **FÖRSTA HJÄLPEN:** Om produkten kommer i kontakt med ögonen eller huden skall kontaktstället omedelbart sköljas med rent vatten i minst 15 minuter. Vid ögonkontakt skall läkare kontaktas omedelbart. Vid intag av produkten skall ett eller två glas vatten eller mjölk drickas. Framkalla kräkning och kontakta omedelbart läkare eller giftcentral.

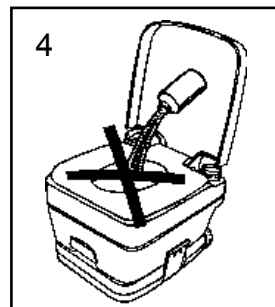
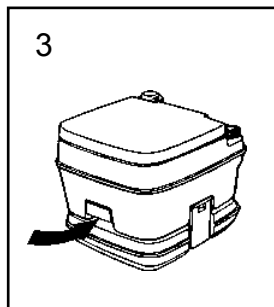
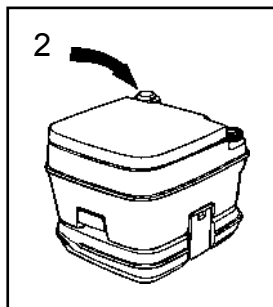
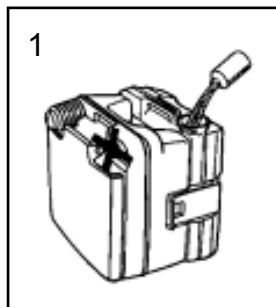

INSTALLING HOLD DOWN BRACKETS

Hold down brackets are provided as standard equipment with marine models or may be purchased separately to secure your RV SaniPottie® portable toilet in the desired location. The following instructions are provided as a guideline for your convenience.

1. Position SaniPottie® portable toilet in desired location. Make sure of adequate clearance for lid and seat in up position and clearance at the sides to unlatch and remove top tank.
2. Open side clasps by pulling outward at top of side clasps.
3. Place hold down brackets, with mounting holes facing away from toilet, under the tank and align with grooves. See Figure 1.
4. Use pencil or awl to mark location of hold down bracket mounting holes.
5. Remove SaniPottie® portable toilet.
6. Attach hold down brackets to the floor or deck with screws provided.
7. Set SaniPottie® portable toilet between brackets and latch in place with side clasps.

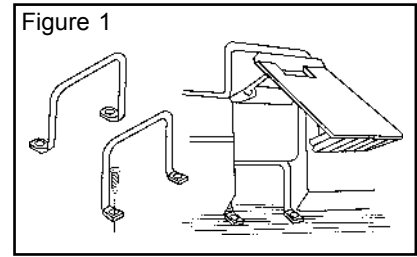

“MSD” PERMANENT INSTALLATION

Portable toilets are legally acceptable for use in vessels not having permanently installed toilets, as determined by the United States Coast Guard. However, some states and the Canadian province of Ontario require a permanently installed portable toilet, such as the 964MSD and 965MSD.

INSTALLATION POSSIBILITIES

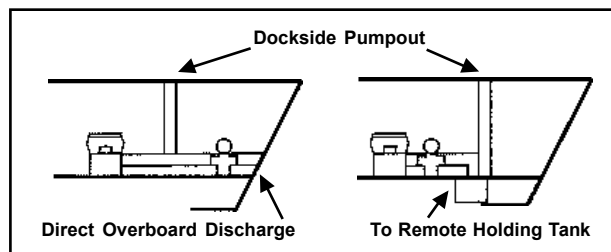
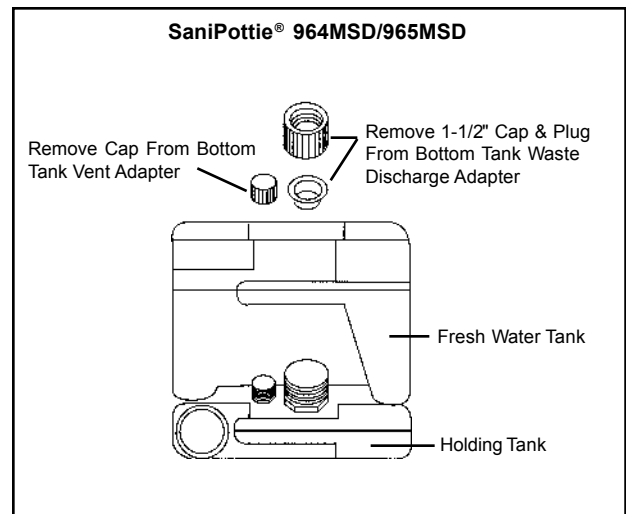
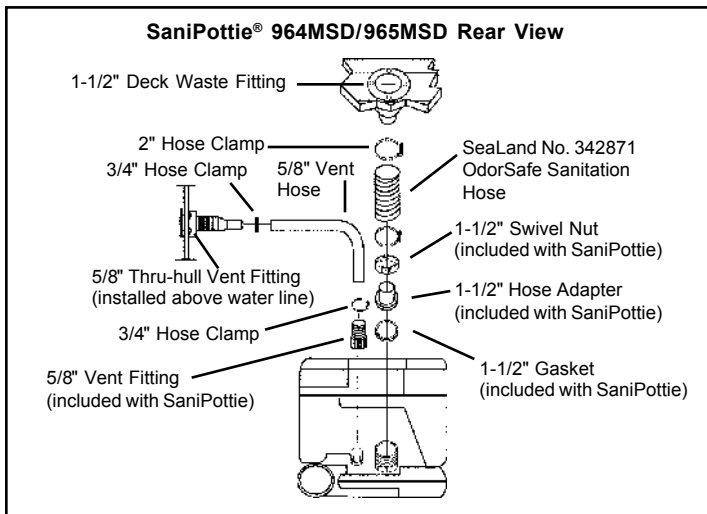

MAINTENANCE

Lubricate slide valve seals periodically with silicone spray or paste lubricant. The slide valve may be removed for cleaning or inspection by simply unscrewing counterclockwise. Clean exterior of toilet with a mild non-abrasive bathroom cleaner.

WINTER USE AND CARE

Use:

When using the SaniPottie® portable toilet in cold or winter weather, the addition of permanent-type antifreeze (in amounts specified on container for four (4) gallons of water) will provide safe winter protection.

CAUTION: DO NOT use alcohol or alcohol base anti-freeze products.

Storage:

To store the SaniPottie® portable toilet over the winter:

1. Empty the top tank and holding tank.
2. Make sure all water is cleared from the bellows pump by depressing pump several times after no water enters the bowl.

Note: A small amount of water may remain in the SaniPottie® portable toilet top tank but will be harmless during winter storage.

SPECIFICATIONS

| Model No. | Description | Capacity (Gallons) | Approx. Weight |
|-----------|-------------------------|--------------------|----------------|
| 962 | Top Tank Bottom Tank | 3.25 2.80 | 12 lb. |
| 964 | Top Tank Bottom Tank | 3.25 2.80 | 12-1/2 lb. |
| 964MSD | Top Tank Bottom Tank | 3.25 3.00 | 13 lb. |
| 965 | Top Tank Bottom Tank | 3.25 5.00 | 13-1/2 lb. |
| 965MSD | Top Tank Bottom Tank | 3.25 5.20 | 14 lb. |
| 966 | Top Tank Bottom Tank | 3.25 5.00 | 13 lb. |

Model 962, 964, 964MSD

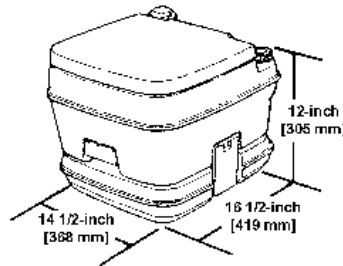

Model 965, 966, 965MSD

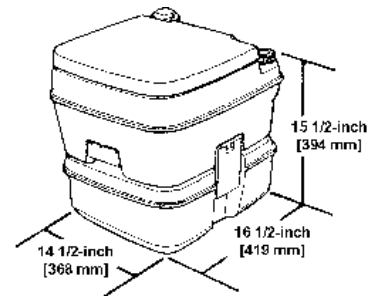

CONVENIENCE PRODUCTS

For optimum performance, use these SeaLand® brand products which are specifically developed to work best in your sanitation system. There are no better holding tank deodorizers and toilet tissues available.

SeaLand® Granulated Deodorant

Six 2-oz. pouches



Part No.
379626002

SeaLand® Liquid Deodorant - Environment Friendly

32-oz. bottle

Part No.
379114032



SeaLand® Liquid Deodorant

Two 8-oz. bottles

Part No.
379224008



SeaLand® Rapid-Dissolving Toilet Tissue

Four 400-sheet rolls

Part No. 379441204

PARTS LIST

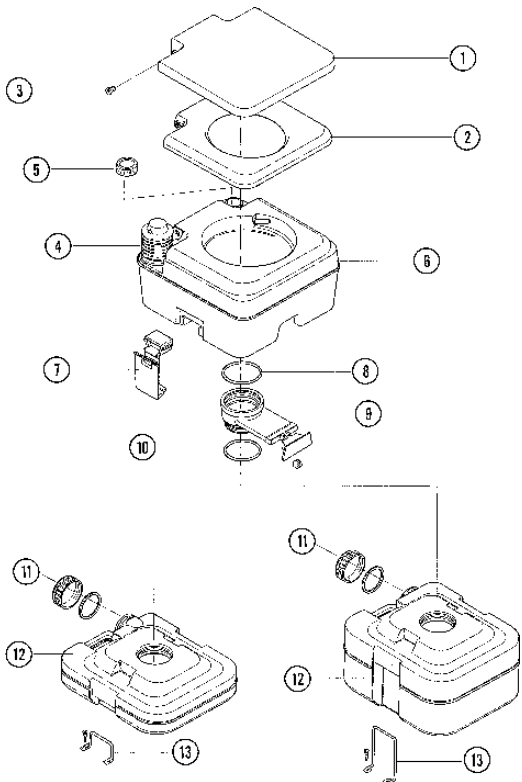
|  | | No. | 962 | 966 | Description | Color |
|---|--------|--------|-----------------------|-------------------------------|-------------|-------|
| <p>Model 962 Model 966</p> | 1 | 230933 | 230933 | Seat Cover | Parchment | |
| | 2 | 230931 | 230931 | Seat | Platinum | |
| | | 341663 | 341663 | | Parchment | |
| | 3 | 341662 | 341662 | Hinge Pin | White | |
| | | 342112 | 342112 | | Parchment | |
| | 4 | 348997 | 348997 | Bellows Assembly | White | |
| | | 310104 | 310104 | | Parchment | |
| | 5 | 310105 | 310105 | Cap, Fresh Water Tank | Platinum | |
| | | 310102 | 310102 | | Parchment | |
| | | 310103 | 310103 | | Platinum | |
| | 6 | 230374 | 230374 | Fresh Water Tank Assembly | Parchment | |
| | | 230375 | 230375 | | Platinum | |
| | 7 | 310067 | 310067 | Latch Assembly | Parchment | |
| 310066 | | 310066 | White | | | |
| 8 | 346549 | 346549 | O-Ring, Top | | | |
| 9 | 230187 | 230187 | Slide Valve Assembly | Parchment | | |
| 10 | 239064 | 239064 | O-Ring, Bottom | White | | |
| | 346401 | 346401 | | | | |
| 11 | 310050 | 310050 | Cap, Holding Tank | Parchment | | |
| 12 | 310031 | 310031 | 2.8 Gal. Holding Tank | White | | |
| | 340791 | | | Parchment | | |
| | 340792 | | | Platinum | | |
| 13 | | 340793 | 5.0 Gal. Holding Tank | Parchment | | |
| | | 340794 | | Platinum | | |
| | 310018 | 310239 | | Hold Down Brackets (optional) | | |

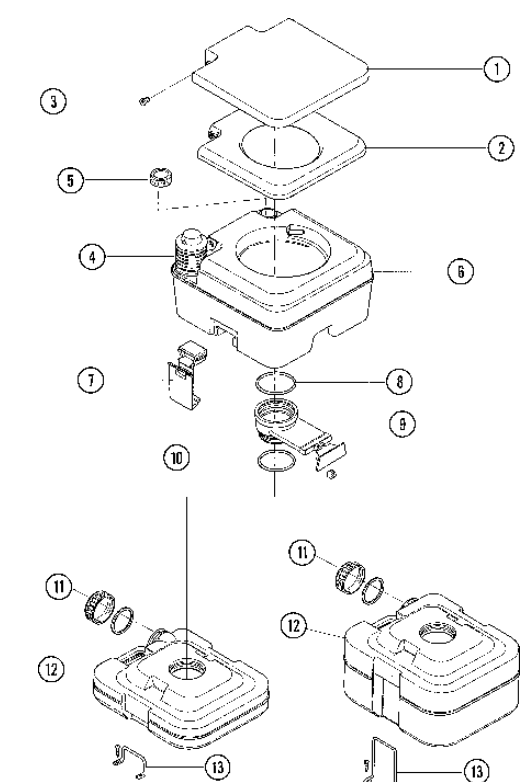
|  | | No. | 964 | 965 | Description | Color |
|---|--------|--------|-----------------------|---------------------------|-------------|-------|
| <p>Model 964 Model 965</p> | 1 | 230933 | 230933 | Seat Cover | Parchment | |
| | 2 | 230931 | 230931 | Seat | Platinum | |
| | | 341663 | 341663 | | Parchment | |
| | 3 | 341662 | 341662 | Hinge Pin | White | |
| | | 342112 | 342112 | | Parchment | |
| | 4 | 348997 | 348997 | Bellows Assembly | White | |
| | | 310104 | 310104 | | Parchment | |
| | 5 | 310105 | 310105 | Cap, Fresh Water Tank | Platinum | |
| | | 310102 | 310102 | | Parchment | |
| | | 310103 | 310103 | | Platinum | |
| | 6 | 230374 | 230374 | Fresh Water Tank Assembly | Parchment | |
| | | 230375 | 230375 | | Platinum | |
| | 7 | 310067 | 310067 | Latch Assembly | Parchment | |
| 310066 | | 310066 | White | | | |
| 8 | 346549 | 346549 | O-Ring, Top | | | |
| 9 | 230187 | 230187 | Slide Valve Assembly | Parchment | | |
| 10 | 239064 | 239064 | O-Ring, Bottom | White | | |
| | 346401 | 346401 | | | | |
| 11 | 310050 | 310050 | Cap, Holding Tank | Parchment | | |
| 12 | 310031 | 310031 | 2.8 Gal. Holding Tank | White | | |
| | 340791 | | | Parchment | | |
| | 340792 | | | Platinum | | |
| 13 | | 340793 | 5.0 Gal. Holding Tank | Parchment | | |
| | | 340794 | | Platinum | | |
| | 310018 | 310239 | | Hold Down Brackets | | |

PARTS LIST (cont'd)

| No. | | | Description | Color |
|-----|--------|--------|-----------------------------------|-----------|
| | 964MSD | 965MSD | | |
| 1 | 230933 | 230933 | Seat Cover | Parchment |
| 2 | 230931 | 230931 | Seat | Platinum |
| | 341663 | 341663 | | White |
| 3 | 341662 | 341662 | Hinge Pin | Parchment |
| | 342112 | 342112 | | White |
| 4 | 348997 | 348997 | Bellows Assembly | Parchment |
| | 310104 | 310104 | | Platinum |
| 5 | 310105 | 310105 | Cap, Fresh Water Tank | Parchment |
| | 310102 | 310102 | | Platinum |
| 6 | 310103 | 310103 | Fresh Water Tank Assembly | Parchment |
| | 230374 | 230374 | | Platinum |
| 7 | 230375 | 230375 | Latch Assembly | Parchment |
| | 310067 | 310067 | | White |
| 8 | 310066 | 310066 | O-Ring, Top | Parchment |
| | 346549 | 346549 | | White |
| 9 | 230187 | 230187 | Slide Valve Assembly | Parchment |
| | 239064 | 239064 | | White |
| 10 | 346401 | 346401 | O-Ring, Bottom | Parchment |
| | 310018 | 310239 | | White |
| 11 | 310050 | 310050 | Hold Down Bracket | Parchment |
| | 310031 | 310031 | | White |
| 12 | 310031 | 310031 | Cap, Holding Tank | Parchment |
| | 310765 | 310766 | | Platinum |
| 13 | 230376 | 230378 | Diptube and Vent Fittings | Parchment |
| | 230377 | | | 230379 |
| 14 | | | 3.0 Gal. Holding Tank w/ Adapters | Parchment |
| | | | | Platinum |
| | | | 5.2 Gal. Holding Tank w/ Adapters | Platinum |

ORDERING PARTS

SeaLand is ready to assist you in the event service is required. Before calling, please have the following information available. Your cooperation in having this information available is appreciated and allows our Customer Service Department to better meet your needs.

1. Model No.
2. Part No., Description, Color and Quantity (See Parts List)

When you have gathered all the required information, refer to the Need Help? section of this manual.

NEED HELP?

We have developed a strong, worldwide dealer network to assist in installing, servicing and maintaining your SaniPottie® portable toilet. For the name of a dealer near you, please call our toll free number **1-800-321-9886** or fax us at **330-496-3097** from 8:00 a.m. to 5:00 p.m. (Eastern Time) Monday through Friday. You may also write us at: Dometic Corporation, PO Box 38, Big Prairie, OH 44611 USA.

IMPORTANT INFORMATION

Why do I need to use a holding tank deodorant?

All types of marine or RV systems offer ideal conditions for odor to grow out of control. When closed, the mechanical seals in the toilets described earlier also act as an odor seal. However, during flushing, odors may enter the bathroom area as air escapes from the system. Odor may also escape to the outside through tank vents.

Which deodorant brand should I buy?

SeaLand is a leading brand of sanitation systems and accessories for the marine and RV industry. **SeaLand** products have been thoroughly tested by an independent laboratory and found to be outstanding in odor control effectiveness. In addition, they also contain biodegradable detergents which break down grease and waste and help keep holding tanks and hoses clean.

SeaLand deodorant products are also compatible with residential septic and municipal waste treatment systems.

Should I use dry or liquid?

The use of **SeaLand** dry, liquid, or Secure holding tank deodorant and cleaner depends on personal preference. You will get the same high quality and odor control effectiveness whichever **SeaLand** deodorant product you choose.

SeaLand liquid mixes instantly and provides excellent odor control in all types of systems. **SeaLand** dry powder is well-suited to recirculating systems and has the extra advantage of taking less storage space.

How much SeaLand deodorant should I use, and how do I add it to my tank?

You can use the following chart to help you with this question. It must be kept in mind, however, that the chart is only a guide. Conditions of extremely warm weather, longer waste holding time and larger tank capacities may require additional **SeaLand** deodorant treatment. Also, to maintain optimum efficiency in odor control, the waste holding tank should be cleaned thoroughly of residue and lime deposits at least once or more each season depending on use.

| Type of Toilet System | Deodorant Charge | | Charging Procedure |
|-----------------------|-------------------------------|--|---|
| | Liquid | Dry | |
| Portable Toilet | 4-oz. with one pint of water. | One 2-oz. packet with one pint of water. | Add to waste holding tank. Never add through toilet bowl. |

Complement your choice of SeaLand deodorizer. Use SeaLand Toilet Tissue.

Low water usage and excessive amounts of tissue can contribute to clogging problems. **SeaLand** tissue is specially designed for rapid disintegration to help prevent clogging.

Important Reminders!

- Always read deodorant packages for warnings and precautions. Keep these products out of reach of children. Do not mix different types or brands of chemicals.
- Do not use chlorine or caustic chemicals, such as laundry bleach or drain openers in the system. These products will cause extensive damage to toilet seals and plumbing system components.
- Always instruct guests in proper operation of your toilet system and caution against disposal of foreign objects.
- Use only mild cleaners or detergents for cleaning your toilet. Strong compounds may contain ingredients which would damage plastic or rubber parts.

SaniPottie® portable toilets and components are covered by one or more U.S. and Foreign Patents.

Made in the U.S.A.

MANUFACTURER'S ONE-YEAR LIMITED WARRANTY

Dometic warrants, to the original purchaser only, that this product, if used for personal, family or household purposes, is free from defects in material and workmanship for a period of one year from the date of purchase.

If this Dometic product is placed in commercial or business use, it will be warranted, to the original purchaser only, to be free of defects in material and workmanship for a period of ninety (90) days from the date of purchase.

Dometic reserves the right to replace or repair any part of this product that proves, upon inspection by Dometic, to be defective in material or workmanship. All labor and transportation costs or charges incidental to warranty service are to be borne by the purchaser-user.

EXCLUSIONS

IN NO EVENT SHALL **DOMETIC** BE LIABLE FOR INCIDENTAL OR CONSEQUENTIAL DAMAGES, FOR DAMAGES RESULTING FROM IMPROPER INSTALLATION, OR FOR DAMAGES CAUSED BY NEGLIGENCE, ABUSE, ALTERATION OR USE OF UNAUTHORIZED COMPONENTS. ALL IMPLIED WARRANTIES, INCLUDING ANY IMPLIED WARRANTY OF MERCHANTABILITY OR FITNESS FOR ANY PARTICULAR PURPOSE, ARE LIMITED TO A PERIOD OF ONE YEAR FROM DATE OF PURCHASE.

IMPLIED WARRANTIES

No person is authorized to change, add to, or create any warranty or obligation other than that set forth herein.

Implied warranties, including those of merchantability and fitness for a particular purpose, are limited to one (1) year from the date of purchase for products used for personal, family or household purposes, and ninety (90) days from the date of purchase for products placed in commercial or business use.

OTHER RIGHTS

Some states do not allow limitations on the duration of an implied warranty and some states do not allow exclusions or limitations regarding incidental or consequential damages; so, the above limitations may not apply to you. This warranty gives you specific legal rights, and you may have other rights which vary from state to state.

To obtain warranty service, first contact your local dealer from whom you purchased this product.



Dometic Corporation • Sanitation Systems
13128 State Rt 226, PO Box 38
Big Prairie, OH 44611
SeaLand Product Customer Service: 1-800-321-9886
(8:00 a.m. - 5:00 p.m. ET)

© Registered; ™ Trademark of Dometic Corporation
© Dometic Corporation