

---

# CONCERTO™

## ALL-CHINA GRAVITY DISCHARGE TOILET

---

### INSTALLATION AND OPERATION

### INSTRUCTIONS

---

**Model 3210 Toilet  
for Recreation Vehicles**



**! WARNING**

This manual must be read and understood before installation, adjustment, service, or maintenance is performed. Modification of this product can result in property damage.



**Dometic Corporation**  
13128 State Rt. 226, P.O. Box 38  
Big Prairie, OH 44611-0038 USA  
330-496-3211  
1-800-321-9886 • Fax: 330-496-3097

© Registered; ™ Trademark of Dometic Corporation  
© Dometic Corporation

---

## TABLE OF CONTENTS

---

Toilet Model Identification .....	2	Flush Mechanism Components .....	9
Toilet Dimensions .....	3	Troubleshooting .....	10
Installation Instructions .....	3 - 6	Parts List .....	11
Toilet Operation .....	6	Wiring Diagram .....	11
Proper Cleaning and Maintenance .....	7	Ordering Parts .....	12
Winterizing .....	7	Customer Service .....	12
Spare Parts .....	7	Three-Year and Ten-Year Limited Warranties .....	12
Deodorants and Special Tissue .....	8		



### **WARNING – ELECTRICAL SYSTEM.**

Turn off electrical power before servicing.

Failure to follow these precautions may result in damage to the toilet.

1. Read and understand the complete contents of this manual before operating or servicing the toilet.
2. Do not use drain openers, alcohol, solvents, etc. in the toilet.
3. Do not dispose of sanitary napkins or other non-dissolving items in the toilet, such as facial tissues or paper towels. These items can cause plugging of the toilet.
4. Make sure all guests understand operation of the toilet.

---

## TOILET MODEL IDENTIFICATION

---

The model identification label is located on the inside wall of the toilet under the access cover. It will show the model number and serial number.

### **DOMETIC CORPORATION**

P.O. BOX 38, 13128 STATE RT 226 (800) 321-9886  
BIG PRAIRIE, OH 44611 USA

MODEL NO. **000**

SERIAL NUMBER

**000000**

Concerto is a trademark, and SeaLand is a registered trademark of Dometic Corporation.

## CONCERTO™ TOILET DIMENSIONS

### MODEL 3210

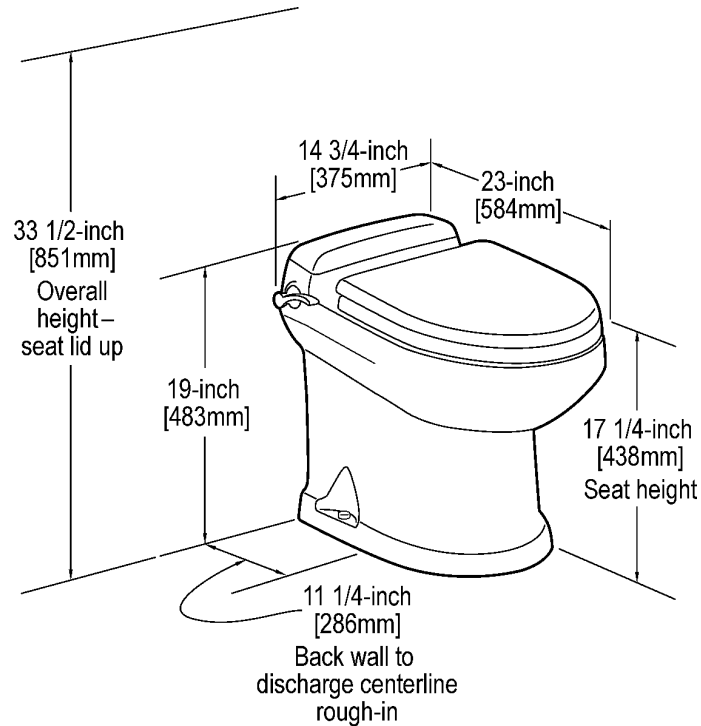

## INSTALLATION INSTRUCTIONS

### System Requirements:

- 2 GPM (10.6 lpm) or larger water pump.
- 1/2-inch (12.7 mm) water line terminating in 1/2-inch MPT fitting (to connect to toilet water supply hose).
- 4-bolt floor (closet) flange. SeaLand flanges available include 3-inch spigot, socket, MPT, or 45-degree swivel socket.
- 12 VDC through 2-amp fuse or circuit breaker. Use 14-gauge stranded copper wire.

STEP 1: Carefully unpack the toilet bowl, rear access lid and floor flange adapter. **CAUTION: HANDLE THE VITREOUS CHINA TOILET AND ACCESS LID WITH CARE. SET THE LID IN AN AREA WHERE IT CANNOT BE BROKEN. PLACE LID ON TOILET ONLY AFTER TOILET INSTALLATION IS COMPLETE.**

STEP 2: Position the china bowl in the space intended. Confirm that adequate clearance is available for using the flush handle and opening the seat and lid.

STEP 3: Mark the floor at the rear corners of the toilet bowl (fig. 1). Measure the distance between the two marks and divide by 2 to find the toilet centerline. Mark the floor at the rear wall for the centerline.

STEP 4: Place a carpenter's square against the back wall, and draw a center line on the floor at least 14 inches (356 mm) long (fig. 2). Mark the centerline for the floor flange at 11-1/4 inches (286 mm) from the wall (fig. 3).

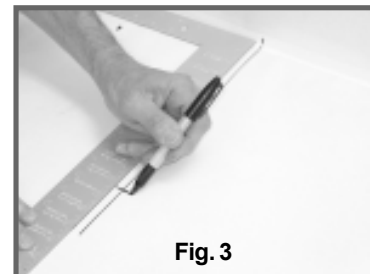
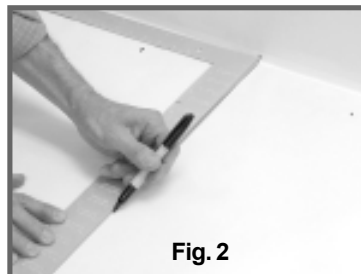
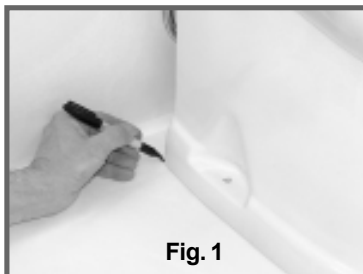

STEP 5a: For through-the-floor water line and electrical wires, mark another centerline 6 inches (152 mm) from the back wall (fig. 4).

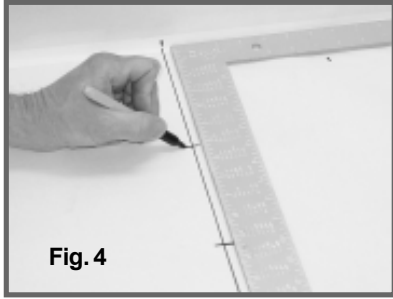

Fig. 4

STEP 5b: For through-the-wall water line and electrical wires, mark a centerline 8 inches (203 mm) up from the floor centerline (fig. 5).

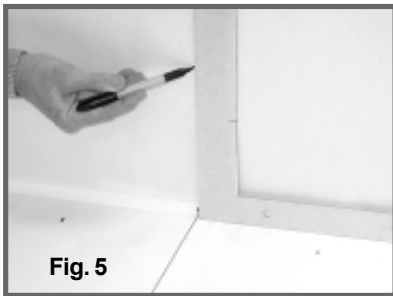

Fig. 5

STEP 6: Make a 4-3/4 inch (121 mm) diameter hole (for most floor flanges) or a 5-1/8 inch (130 mm) diameter hole (for swivel joint floor flange) at the centerline mark furthest from the wall. Make a 1 inch (25 mm) hole at the mark closer to the wall for the water line and electrical wires (fig. 6).

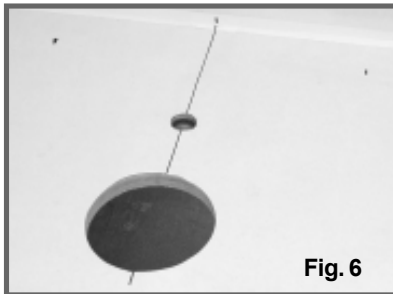
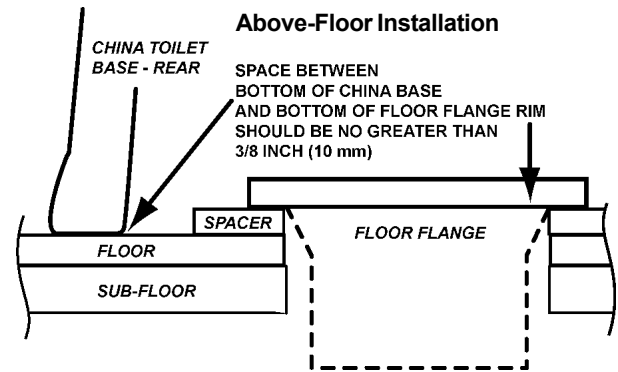
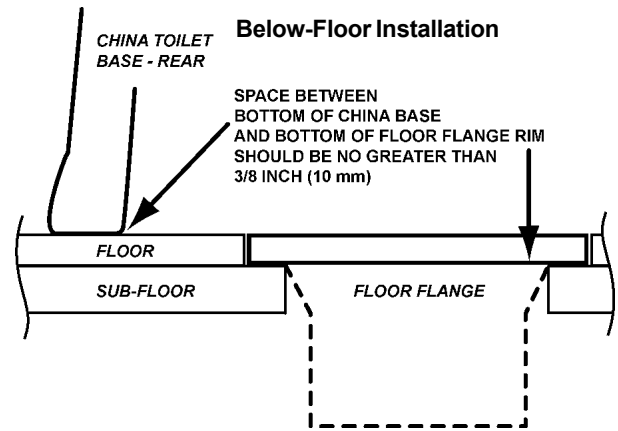

Fig. 6

**IMPORTANT:** The preferred installation method is to mount the floor flange directly on the finished floor. However, if the bottom of floor flange and bottom of china toilet must be mounted at different heights, the floor flange must be mounted within 3/8 inch (10 mm) of the bottom of the toilet (see illustrations in next column) or leakage will result.



STEP 7: Insert floor flange into larger hole and secure to the floor with #12x3/4-inch long flat head wood or sheet metal screws (fig. 7).

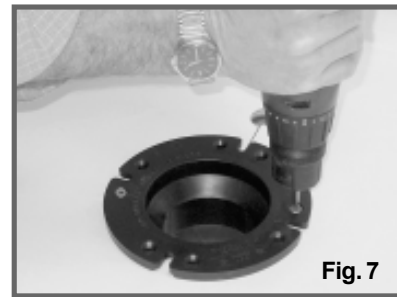

Fig. 7

STEP 8: Route 1/2-inch (13mm) PEX tubing through the smaller hole and install a PEX 1/2-inch MPT fitting (fig. 8).

**NOTE:** A water shut-off valve should be installed in the water line to the toilet for maintenance requirements.

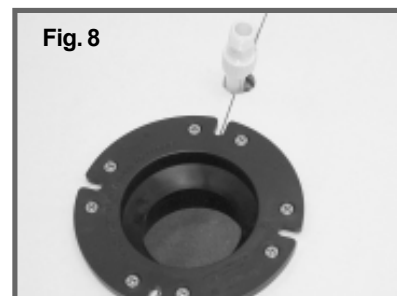
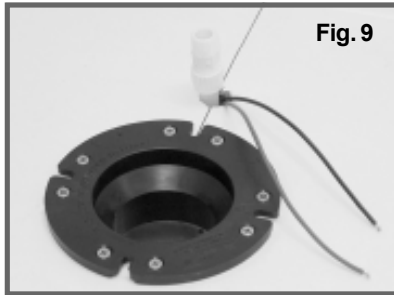

Fig. 8

**STEP 9: WITH THE ELECTRICAL POWER OFF**, route #14 gauge stranded copper wire from 12 VDC ground and positive 12 VDC from the fuse panel through a 2-amp fuse or circuit breaker. Leave at least 12 inches (305 mm) of wire for connecting to toilet (fig. 9).



**STEP 10:** Connect the holding tank to the bottom of the discharge flange.

**STEP 11:** Slide the four T-bolts into the slots of the floor flange. Install the flange gasket over the T-bolts (fig. 10).

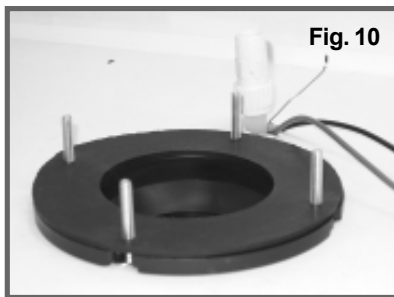

**STEP 12:** Install floor flange adapter with words “THIS SIDE UP” facing up. Tighten adapter to floor flange using four flat washers and hex nuts. Tighten in criss-cross pattern (fig. 11).

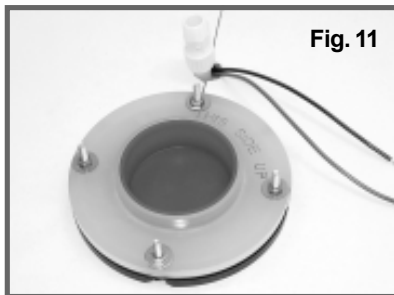

**IMPORTANT:** If replacing an existing toilet with 2-bolt floor flange, drill two 5/16-inch dia. holes in old floor flange that align with two additional holes in floor flange adapter. Use two #10 or 12 x 1-1/2-inch wood screws and washers for these drilled holes, and two T-bolts with flat washers and nuts to fasten flange gasket and floor flange adapter to old floor flange. Do not use old hardware or seal.

**STEP 13:** Temporarily set the toilet in place on the floor flange (fig. 14).



**STEP 14:** Mark the holes for the two toilet mounting bolts (fig. 15).

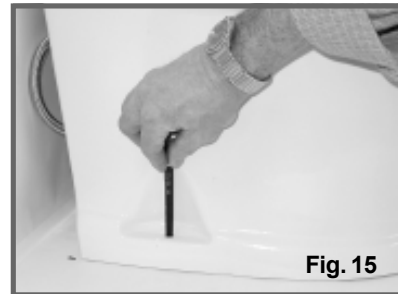

**STEP 15:** Pick up toilet and set aside. Drill 3/16-inch pilot holes in the floor (fig. 16).



**STEP 16:** With toilet close to floor flange, connect flexible water supply hose to the water line fitting (fig. 17).

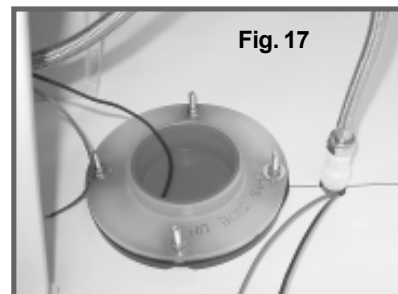

STEP 17: Connect the positive (+) 12 VDC lead to the red wire and the negative (-) lead to the black wire (fig. 18).

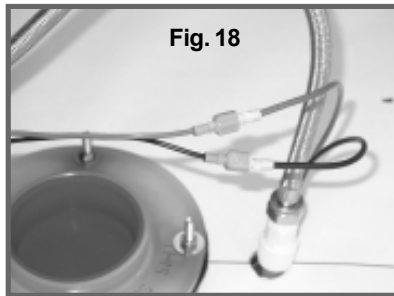

STEP 18: REMOVE RED CAP FROM MIDDLE OF FLANGE ADAPTER BEFORE FINAL TOILET INSTALLATION.

**IMPORTANT – DO NOT ATTEMPT TO SLIDE THE TOILET OVER THE FLANGE ADAPTER. THE TOILET MUST BE SET DOWN OVER THE ADAPTER TO PREVENT POSSIBLE DAMAGE.**



STEP 19: Set the toilet in place (fig. 19) and secure to floor with the #14x2-1/2 inch long lag bolts (fig. 20). Install decorative bolt caps by pushing them onto bolt heads (fig. 21).

STEP 20: Place the rear access cover on the back of the toilet. Press down firmly to seat the fastening strips.

STEP 21: Turn on electrical power and water to toilet. Lift flush handle and fill toilet bowl with water. Wait one hour, then inspect the floor around and under the rear of the toilet for leaks or dampness.

## CONCERTO TOILET OPERATION

1. Fill freshwater tank and add deodorant to holding tank through toilet bowl.
2. Make sure all guests understand the operation of the toilet system and the flushing instruction label is easy for guests to read. **This label is located under the seat, and is easily read when the seat is raised.**
3. Shut off the toilet system before servicing and do not leave the vehicle with toilet system breaker on.
4. **Never use drain openers, alcohol, solvents, etc. in the toilet.**
5. If the toilet does not function properly, refer to the Troubleshooting section of this manual and repair as necessary. If problem persists, contact your local SeaLand product dealer or see the Customer Service section of this manual.

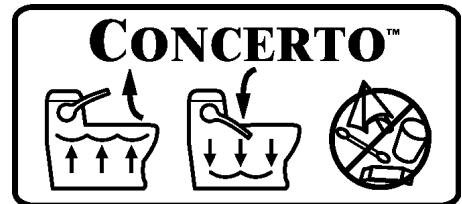

### FLUSHING OPERATION

1. To add water to the toilet before using (if necessary), raise flush handle until desired water level is reached.

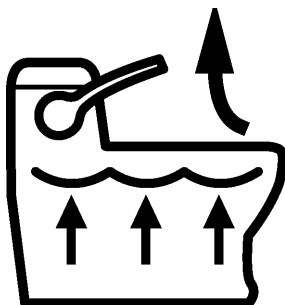

2. To flush toilet, press flush handle down. Release handle to let flush ball snap back into position.

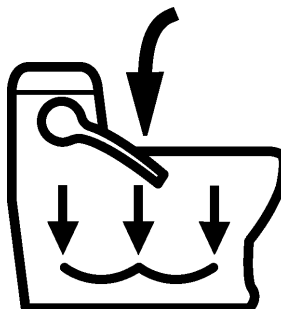

3. Do not dispose of sanitary napkins or other non-dissolving items in toilet, such as facial tissue or paper towels. These items can plug the system.

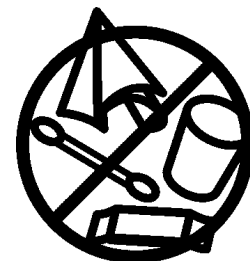

## PROPER CLEANING AND MAINTENANCE

The Concerto toilet should be cleaned regularly for maximum sanitation and operational efficiency. You can clean it just as you would a household toilet. **Do not use caustic chemicals, such as drain-opening types, as they will damage the seals.**

**BOWL CLEANING:** For stubborn stains, use SeaLand Bowl and Seal Cleaner (fig. A). It's manufactured especially for use with SeaLand ceramic toilets. In certain locations where water is hard, a build-up of lime may dull the toilet bowl finish. Restore the shine with this cleaner. If you cannot find our brand in your area, contact SeaLand Product Customer Service for your nearest dealer. If it is not available, you can also use Bar Keepers Friend® cleanser. It is not necessary to vigorously scrub with either product. Please follow label instructions.



Fig. A

**SEAL CLEANING:** After an extended time, mineral deposits from hard water can build up under the edge of the rubber bowl seal, resulting in a slow leakdown of water from the bowl. To prevent this mineral build-up, periodically clean under the bowl seal with SeaLand Bowl and Seal Cleaner (fig. B).



Fig. B

1. Shut off water supply.
2. Apply cleaner onto the seal cleaning tool (supplied with new toilet), open the flush ball by pressing on flush lever, and scrub under the seal. Make sure to push bristles between bottom of seal and top of flush ball surface to scrub all parts of seal that come into contact with flush ball.
3. Close ball and wait 2-3 minutes.
4. Open flush ball. Use brush and water to rinse away cleanser and loosened deposits.

## WINTERIZING

At the end of each traveling season, the Concerto toilet should be winterized for storage, by either draining or using potable water-safe antifreeze in the system.

### To drain:

1. Empty the blackwater tank.
2. Thoroughly flush system with fresh water.
3. Empty freshwater tank and blackwater tank.
4. Add freshwater antifreeze to freshwater tank.
5. Flush freshwater antifreeze through toilet and into the blackwater tank. Each installation is different, so amounts may vary. User discretion is required to assure adequate protection.
6. Turn off electrical power.

**NOTE:** Use nontoxic antifreeze designated for potable water systems. (See vehicle owner's manual.)

**CAUTION:** Never use automotive-type antifreeze in freshwater systems.

## SPARE PARTS

It is recommended that the following spare parts be kept available at all times:

Description	Part Number	Quantity	Description	Part Number	Quantity
Flush Ball Seal	310819	1	Water Valve	310821	1
Flush Ball	see parts list	1	Vacuum Breaker Assembly	see parts list	1

---

## DEODORANTS AND SPECIAL TISSUE

---

Your Concerto toilet requires the regular addition of a deodorant product to reduce malodors and to help break down holding tank contents. Several factors should be considered in selecting a deodorant product.

**Liquid or Dry:** Liquid products obviously work more quickly by readily going into solution. Granulated powder formulations, on the other hand, have the advantage of requiring less storage space and are less likely to leak if the package is inadvertently damaged.

**Formaldehyde versus Non-Formaldehyde:** Dometic manufactures both types of deodorants. Generally speaking, formaldehyde formulas control odor very effectively at all temperatures and with all degrees of water hardness. SeaLand® Environment-Friendly brand, which is formaldehyde free, is similarly effective.

**How Much Deodorant and How to Add It:** The deodorant is added directly into the toilet bowl, then flushed into the holding tank. Follow bottle or package instructions. Conditions of extremely warm weather, longer waste holding time and larger tank capacities may require more deodorant treatment. Also, to maintain optimum efficiency in odor control, the waste holding tank should be cleaned thoroughly at least once or more each season, depending on use.

**Why Not Use Household Toilet Paper in Your Concerto Toilet?** Household tissues often contain adhesives which bond together the paper fibers from which the tissue is made. The adhesives prevent the tissue from breaking apart, and their use in “ultra-low flow” systems can cause system clogging. SeaLand tissue is especially designed for use in low water toilet systems. Its rapid dissolving properties minimize the amount of residual paper in the holding tank and allow deodorizers to work more efficiently.

**SeaLand versus Other Brands:** SeaLand constantly strives to provide our system owners with effective products that have minimal environmental impact and good value. Many deodorant products do not measure up to our standards of performance and value.



**SeaLand® Granulated Deodorant**  
Six 2-oz. pouches  
**Part No. 379626002**



**SeaLand® Liquid Deodorant**  
Two 8-oz. bottles  
**Part No. 379224008**

**SeaLand® Rapid-Dissolving Toilet Tissue**  
Four 400-sheet rolls  
**Part No. 379441204**



**SeaLand® Liquid Deodorant - Environment Friendly**  
32-oz. bottle  
**Part No. 379114032**





## FLUSH MECHANISM COMPONENTS

1. To access base assembly components, remove decorative screw caps and unscrew two bolts that hold china toilet to floor.

2. Remove access cover from top of china toilet and set it aside.



3. Lift china toilet straight up from base and set it down just in front of floor flange. Turn off water to toilet and disconnect flexible water line. Disconnect power wires if necessary.

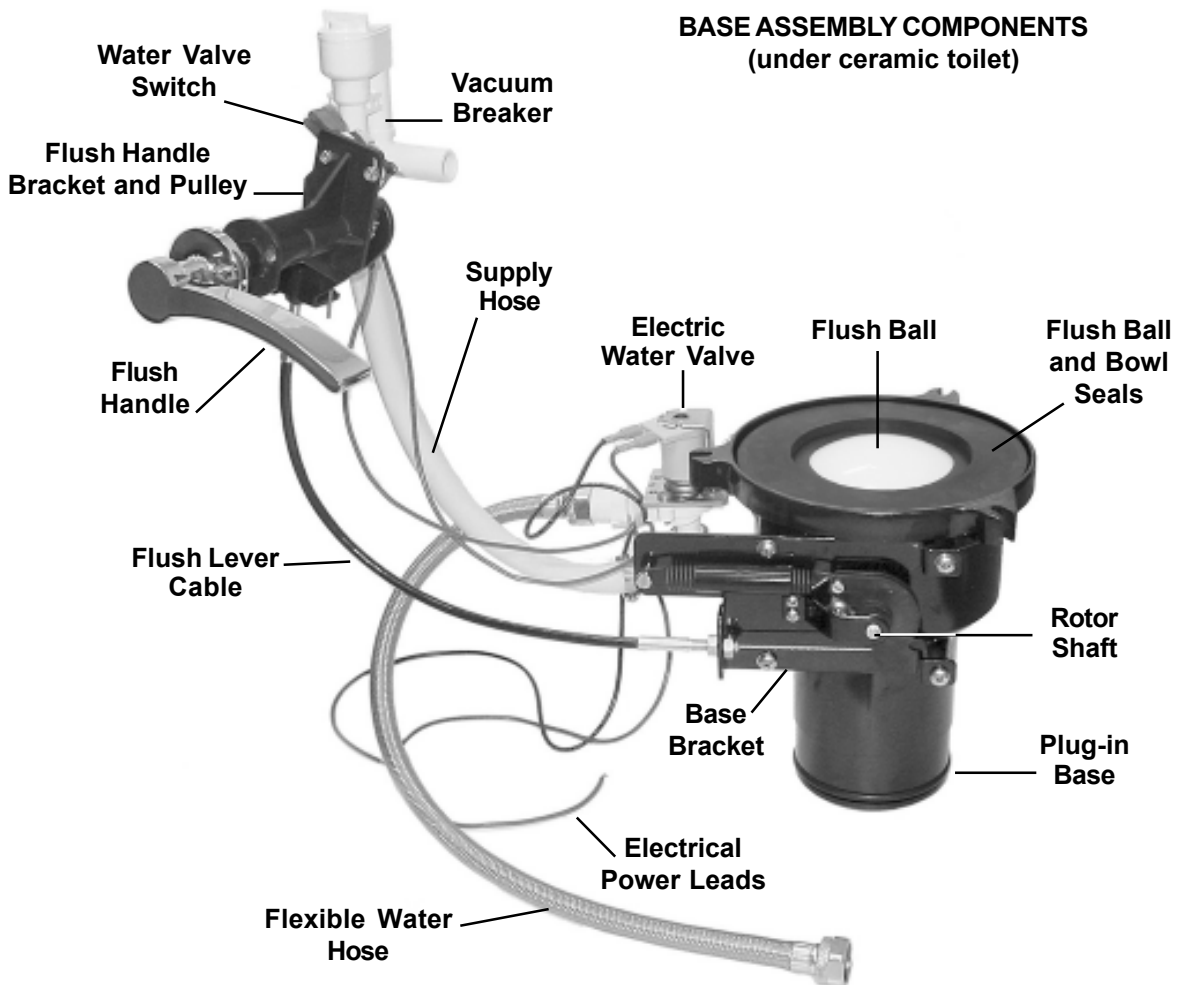

**BASE ASSEMBLY COMPONENTS**  
(under ceramic toilet)

## TROUBLESHOOTING

**Important: Always turn off electrical power and water to the toilet for disassembly.**

Problem	Possible Cause	Service Instructions
1. Toilet emits odor (flush ball open).	<ul style="list-style-type: none"> <li>a. Odor emitting from base of toilet.</li> <li>b. Plugged holding tank vent line.</li> </ul>	<ul style="list-style-type: none"> <li>a. Use SeaLand brand deodorants.</li> <li>b. Clear obstructions from vent line.</li> </ul>
2. Water will not stay in bowl.	<ul style="list-style-type: none"> <li>a. Improper seal between flush ball and seal due to dirt or debris on underside of flush ball seal.</li> <li>b. Worn or damaged flush ball and seal.</li> </ul>	<ul style="list-style-type: none"> <li>a. Clean underside of flush ball seal (see cleaning method on page 7).</li> <li>b. Remove toilet from floor, disassemble bowl from base and replace flush ball and seal.</li> </ul>
3. Water will not enter bowl.	<ul style="list-style-type: none"> <li>a. Water valve fuse is blown.</li> <li>b. Water valve filter screen is clogged.</li> <li>c. Defective water valve.</li> <li>d. Defective flush switch.</li> </ul>	<ul style="list-style-type: none"> <li>a. Replace fuse located in fuse panel.</li> <li>b. Clean filter screen.</li> <li>c. Replace water valve.</li> <li>d. Replace flush switch.</li> </ul>
4. Water will not shut off and overflows bowl.	<ul style="list-style-type: none"> <li>a. Dirt or debris lodged in water valve seal.</li> <li>b. Defective water valve.</li> </ul>	<ul style="list-style-type: none"> <li>a. Disassemble and clean water valve.</li> <li>b. Replace water valve.</li> </ul>
5. Flush ball will not open.	<ul style="list-style-type: none"> <li>a. Flush cable is loose or broken.</li> <li>b. Base pulley broken.</li> </ul>	<ul style="list-style-type: none"> <li>a. Tighten or replace cable.</li> <li>b. Replace base pulley.</li> </ul>
6. Hand spray unit leaks.	<ul style="list-style-type: none"> <li>a. Hand sprayer is defective.</li> </ul>	<ul style="list-style-type: none"> <li>a. Replace hand sprayer.</li> </ul>
7. Water does not enter toilet bowl properly.	<ul style="list-style-type: none"> <li>a. Insufficient water flow rate at toilet.</li> <li>b. Water valve clogged.</li> <li>c. Plugged rim wash holes in toilet.</li> </ul>	<ul style="list-style-type: none"> <li>a. Check water flow rate at toilet. Rate should be 2 gpm (7.6 lpm) at toilet.</li> <li>b. Remove and clean screen located inlet of water valve.</li> <li>c. Clean holes. If still a problem, replace the toilet bowl.</li> </ul>
8. Water leaking from water valve.	<ul style="list-style-type: none"> <li>a. Water valve body cracked due to freeze damage.</li> <li>b. Water line connection is loose or not seated properly.</li> <li>c. Defective water valve.</li> <li>d. Stripped threads.</li> </ul>	<ul style="list-style-type: none"> <li>a. Replace water valve.</li> <li>b. Insure that threads are not cross-threaded and tighten.</li> <li>c. Replace water valve.</li> <li>d. Replace water valve.</li> </ul>
9. Water leaking from under toilet.	<ul style="list-style-type: none"> <li>a. Toilet loose.</li> <li>b. Defective component under china bowl: vacuum breaker assembly, water hose/fittings, water valve assembly, upper bowl seal, base O-ring, rotor shaft, or plastic base.</li> <li>c. Worn or defective floor flange seal.</li> <li>d. Cracked china bowl.</li> </ul>	<ul style="list-style-type: none"> <li>a. Tighten toilet mounting bolts.</li> <li>b. Remove floor bolts and turn toilet to one side as much as possible, keeping telescoping base in floor flange adapter. Flush toilet to find source of leak. Tighten loose connections or replace defective component.</li> <li>c. Replace seal.</li> <li>d. Replace china toilet.</li> </ul>

# PARTS LIST

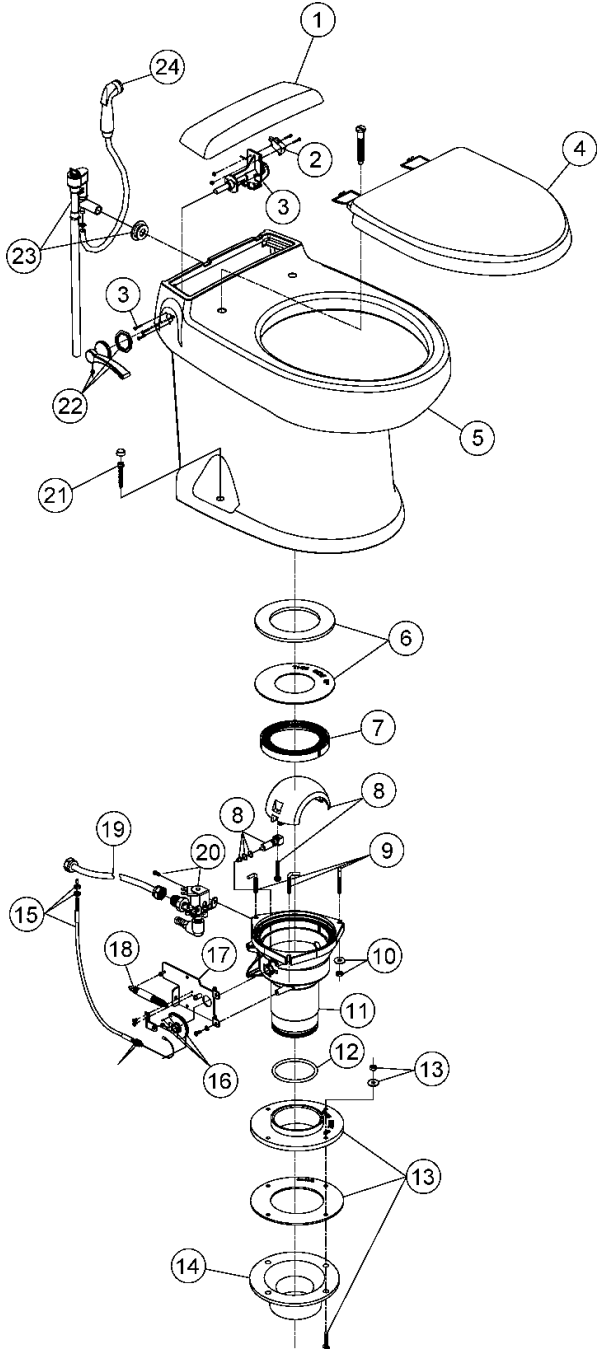

Item	Part No.	Description
1	385311001	Access Cover, White
	385311002	Access Cover, Bone
2	385311003	Flush Switch Assembly
3	385311004	Flush Handle Shaft Kit
4	385311005	Seat and Lid, White
	385311006	Seat and Lid, Bone
5	385311007	China Bowl, White
		(incl. item 1 and locking material)
	385311008	China Bowl, Bone
		(incl. item 2 and locking material)
6	385311009	Bowl Seal Kit
7	600343534	Ring, Base Insert
8	385311010	Shaft, Flush Ball Kit
9	385311011	J-Bolts (incl. nuts and washers)
10	385311012	Plastic Nuts and Washers
11	385311028	Concerto Base
12	600344609	O-Ring, 3.1 x 3.5 x .21
13	385311013	Floor Flange Adapter Kit
14	385345889	Floor Flange Adapter, 3" MPT
		(sold separately)
	385345892	Floor Flange Adapter, 3" Socket
		(sold separately)
	385343765	Floor Flange Adapter, 3" Spigot
		(sold separately)
	307344653	Floor Flange Adapter, 45° Swivel
		(sold separately)
15	385311014	Flush Cable Kit
16	385311015	Pulley Kit
17	385311016	Base Bracket
18	385311017	Return Spring Kit
19	385311018	Supply Hose
20	385311019	Water Valve Kit
21	385311020	Mounting Hardware, Chrome
	385311021	Mounting Hardware, Gold
	385311022	Mounting Hardware, Nickel
22	385311023	Flush Handle, Chrome
	385311024	Flush Handle, Gold
	385311025	Flush Handle, Nickel
23	385311026	Vacuum Breaker Kit
	385311027	Vacuum Breaker Kit with Hand Spray
24	385310809	Hand Spray, White

# WIRING DIAGRAM

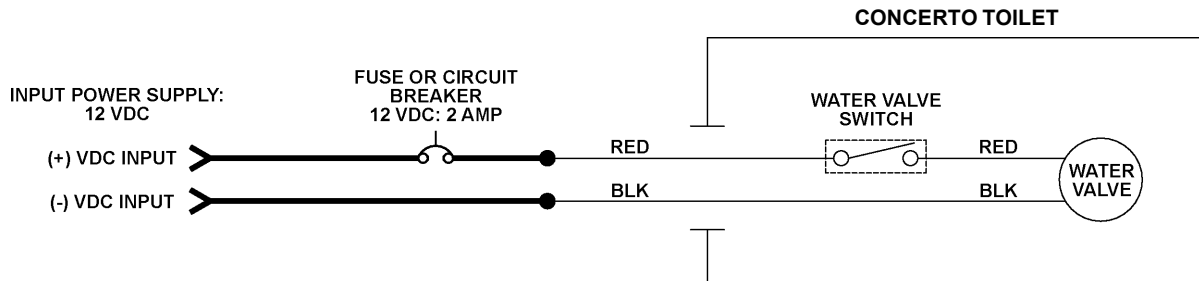

NOTES:  
HEAVY LINES REPRESENT 14 GA. STRANDED COPPER WIRE.  
ALL OTHER WIRE CAN BE 18 GA. STRANDED COPPER WIRE.

---

## ORDERING PARTS

---

Dometic is ready to assist you in the event service is required. Before calling, please have the following information available. Your cooperation in having this information ready is appreciated and allows us to better meet your needs.

1. Toilet Model Number
2. Serial Number
3. Part Number, Description and Quantity (see Parts List)

---

## CUSTOMER SERVICE

---

There is a strong, worldwide network to assist in servicing and maintaining your sanitation system. For the Authorized Service Center near you, please call from 8:00 a.m. to 5:00 p.m. (ET) Monday through Friday.

Telephone: **1 800-321-9886** U.S.A. and Canada  
**330-496-3211** International

Email: **sealand@dometicusa.com**

Mail: **Dometic Corporation**  
**13128 SR 226**  
**PO Box 38**  
**Big Prairie, OH 44611**

---

## MANUFACTURER'S THREE-YEAR AND TEN-YEAR LIMITED WARRANTIES

---

Dometic warrants, to the original purchaser only, that this Concerto™ gravity discharge toilet, if used for personal, family or household-like purposes, is free from defects in material and workmanship for a period of three (3) years from the date of purchase.

Dometic also warrants, to the original purchaser only, that the vitreous china toilet bowl will not discolor, stain, scratch or craze for a period of ten (10) years if used for personal, family or household-like purposes, and is regularly cleaned as described in the product's owner's manual.

If this Dometic product is placed in commercial or business use, it will be warranted, to the original purchaser only, to be free of defects in material and workmanship for a period of ninety (90) days from the date of purchase.

Dometic reserves the right to replace or repair any part of this product that proves, upon inspection by Dometic, to be defective in material or workmanship. All labor and transportation costs or charges incidental to warranty service are to be borne by the purchaser-user.

### EXCLUSIONS

IN NO EVENT SHALL **DOMETIC** BE LIABLE FOR INCIDENTAL OR CONSEQUENTIAL DAMAGES, FOR DAMAGES RESULTING FROM IMPROPER INSTALLATION, OR FOR DAMAGES CAUSED BY NEGLIGENCE, ABUSE, ALTERATION, OR USE OF UNAUTHORIZED COMPONENTS. THIS INCLUDES FAILURES WHICH MAY RESULT FROM NOT FOLLOWING THE WINTERIZATION OR CLEANING PROCEDURES AS DESCRIBED ON PAGE 7 OF THIS MANUAL. ALL IMPLIED WARRANTIES, INCLUDING ANY IMPLIED WARRANTY OF MERCHANTABILITY OR FITNESS FOR ANY PARTICULAR PURPOSE, ARE LIMITED TO A PERIOD OF ONE (1) YEAR FROM DATE OF PURCHASE.

### IMPLIED WARRANTIES

No person is authorized to change, add to, or create any warranty or obligation other than that set forth herein.

Implied warranties, including those of merchantability and fitness for a particular purpose, are limited to one (1) year from the date of purchase for products used for personal, family or household-like purposes, and ninety (90) days from the date of purchase for products placed in commercial or business use.

### OTHER RIGHTS

Some states do not allow limitations on the duration of an implied warranty, and some states do not allow exclusions or limitations regarding incidental or consequential damages; so, the above limitations may not apply to you. This warranty gives you specific legal rights, and you may have other rights which vary from state to state.

To obtain warranty service, first contact your local dealer from whom you purchased this product.



® Registered; ™ Trademark of Dometic Corporation  
® Bar Keepers Friend is a registered trademark of SerVaas Laboratories.  
® Teflon is a registered trademark of DuPont Co.  
® Uniseal is a registered trademark of Injection Plastics, Inc.  
© 2003 Dometic Corporation

600344636 6/03

**Dometic Corporation**  
13128 State Rt 226, PO Box 38  
Big Prairie, Ohio 44611  
SeaLand Product Hotline 1-800-321-9886  
(8:00 a.m. - 5:00 p.m. ET)